

ARA61

12V PSU Module

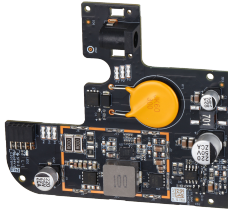

Scene

Suitable for scenes that do not have access to AC power supplies.

Technical Specification

Technical

Output Voltage	12 VDC
Maximum Load Output	1.5 A

General

Power Supply	6–24 VDC power input
Operating Temperature	–10 °C to +55 °C (+14 °F to +131 °F)
Operating Humidity	10%–90% (RH)
Product Dimensions	89 mm × 79 mm × 12 mm (3.50" × 3.11" × 0.47")
Net Weight	34.76g (0.01 lb)
Gross Weight	81.11g (0.02 lb)
Packaging Dimensions	92 mm × 84 mm × 40 mm (3.62" × 3.31" × 1.57")

Ordering Information

Type	Model	Description
Alarm Accessory	ARA61	12V PSU Module

- Supports 6-24 VDC power input.
- The AC power module of Hub 2 can be replaced.
- A round hole connector can be used externally to connect with a 2-pin terminal block.

Installation

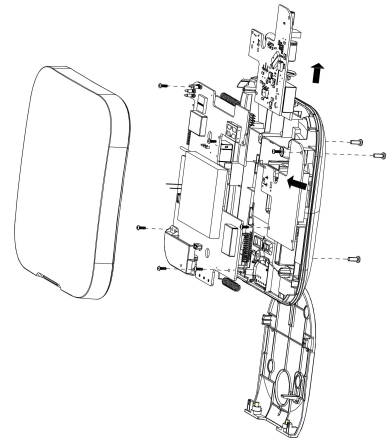

Dimensions (mm[inch])

